

Instructions for use

Flexible Video Ureterorenoscope

H Vision: HUV-01

HU Vision: HU30, HU32



Description

Thanks for buying the Flexible Video Ureterorenoscope.

Before using this product, please read this Instructions for use carefully to ensure correct use.

Please keep this Instructions for use properly for consultation.

E-

Product name:	Flexible Video Ureterorenoscope
Date of production:	See the label
Service life:	3 years
Compilation/revision date:	2020-6-18
Version of Instructions for use:	V1.0
Software version:	1.0.0
Product performance, structure and composition:	Composed of image processor, operating handle and accessories of power cord, data transmission wire ,ground wire, Equipotential line,etc.
Application scope:	Applicable to endoscopic examination and surgery on urethra and kidney.
Name of registrant/production enterprise:	Shenzhen HugeMed Medical Technical Development Co., Ltd.
Address:	6B, Block A, Tempus Building, 1st Qingshuihe Road, Luohu District Shenzhen City, Guangdong, China
Production address:	516-1,416-1, Building 2, No.1 Mawu Road, Baoan Community, Yuanshan Street, Longgang District, Shenzhen City
After-sales service company:	
Contact information:	Shenzhen HugeMed Medical Technical Development Co., Ltd. Tel.: +86-755-22275866 E-mail: service@hugemed.net
Website:	http://www.hugemed.net

Intellectual Property Rights

The intellectual property rights of this Instructions for use and its corresponding product belong to Shenzhen HugeMed Medical Technical Development Co., Ltd. (hereinafter referred to as “HugeMed”).

© 2017 Shenzhen HugeMed Medical Technical Development Co., Ltd., copyright reserved. Any individual or organization shall not copy, modify or translate any part of this Instructions for use without the written consent of HugeMed.

 ,  HugeMed and  宏济医疗 are the registered trademarks or trademarks of HugeMed.

Declaration

HugeMed has the right of final interpretation to this Instructions for use.

HugeMed has the right to make any modification to this Instructions for use without prior notice. The revised content will be included in the new version of this Instructions for use.

HugeMed does not bear any responsibility for software and equipment that are not provided by HugeMed and its distributors.

HugeMed will bear responsibilities for the safety, reliability and performance of products only when the following requirements are met at the same time:

- Assembly, extension, readjustment, improvement and maintenance must be carried out by the professionals approved by HugeMed;
- All replaced components, supporting accessories and consumables during maintenance are original or are approved by HugeMed;
- Relevant electrical equipment conforms to the requirements of MDR standards and this Instructions for use.
- Product operation is carried out in accordance with this Instructions for use.

Warranty and maintenance service

Standard warranty period is one year for this product, and half a year for main accessories such as power cord, data transmission wire, and ground wire. Consumables refer to disposable consumable materials that need to be replaced after each use, with no warranty period.

In case of disagreement or separate agreement on the warranty period and the above-mentioned standard warranty period between the retailer and your sales contact, please call at the HugeMed's free service hotline +86-755-22275899 for consultation and confirmation. For those not confirmed by HugeMed, please contact the retailer for confirmation in time.

Warranty period starts from the "Installation date" filled in a random *Warranty Card*, which is the only proof for calculation of the warranty period. In order to safeguard your rights and interests, please supervise and urge the installer to return the second page of the *Warranty Card* to HugeMed within 30 days from the installation date; In case of failing to return the *Warranty Card* corresponding to the product you purchased to HugeMed on time, the start date of the warranty period will be postponed for 45 days from the "Stock-out date" identified on the package box.

Within the warranty period, free after-sales service will be provided for the product; however, please note that, even during the warranty period, HugeMed will provide paid services in case of maintenance due to the following reasons, and you shall pay the maintenance fee and accessories expenses:

- Artificial damage;
- Incorrect use;
- Network voltage exceeds the specified scope of the product;
- Irresistible natural disasters;
- Replace or use components and accessories not approved by HugeMed, or the product is repaired by personnel not authorized by HugeMed;
- Other faults due to non-product reasons.

After the warranty period expires, HugeMed continues to provide paid services. If you

refuse to pay or delay in paying the maintenance fees, HugeMed will suspend the maintenance services temporarily until the payment is made.

After-sales service company

After-sales service company: Customer Service Department of Shenzhen HugeMed Medical Technical Development Co., Ltd.

After-sales address: 6F, Block A, Tempus Building, 1st Qingshuihe Road, Luohu District Shenzhen City, Guangdong, China

Post code: 518024

After-sales hotline: +86-755-22275899

Sales hotline: +86-755-22275866

Fax: +86-755-22275833

Official website: www.hugemed.net

Warning

- This product shall be operated by professional clinicians, experts of medical electrical equipment or trained clinical medical staff in specified occasions. Personnel who operate this product shall be trained completely. Any personnel who are not authorized or not trained shall not carry out any operation.
 - Careful operation can avoid accidents!
 - Daily cleaning and maintenance of instrument must be done.
 - In case of repair, original fittings shall be used as far as possible.
-
-

Foreword

1. Description

This Instructions for use (hereinafter referred to as “IFU”) describes the purpose, functions and operations of the product in detail. Before use, please carefully read and understand the IFU to ensure correct use of this product, and the safety of both patients and operators.

The IFU introduces the product with the most complete configuration, and parts of the contents may not be applicable to the product you purchased. In case of any doubt, please feel free to contact our company.

These descriptions include the precautions of how to operate the Ureterorenoscope safely, correctly, and effectively, which is conducive to reduce faults and maintenance cost, shorten the shutdown time, and improve the reliability and lengthen the service life of the instrument. It can be used not only as Instructions for use, but also as a reference manual. Therefore, this IFU must be kept beside the equipment for use at any time.

Prior to the first use, please carefully read the chapter I Safety.

2. Applicable objects

The IFU is only applicable for use by the trained clinical medical staff.

3. Figures

All figures in this IFU are only for reference, and the settings or data in figures may not be consistent with those actually displayed on the product.

4. Conventions

- ***Italic Bold*** words are used in this IFU to show the sections that are quoted.
- “Dangerous”, “warning” and “be careful” and other terms are used in this IFU to prompt the dangerous information and its severity degree.

Contents

Description.....	I
Intellectual Property.....	II
Declaration.....	II
Warranty and maintenance service.....	III
After-sales service company.....	V
Foreword.....	VI
Contents.....	VII
1. Important Information – Please Read Before Use.....	1
1.1 Intended use.....	1
1.2 Description of intended use.....	1
1.3 Warnings, Cautions, Notes.....	2
1.4 Warning.....	3
1.5 Caution.....	5
1.6 Note.....	5
2. System Parts.....	6
2.1 System chart.....	6
2.2 Description of the System.....	9
2.3 Explanation of Symbols Used.....	12
3. Inspection and Operation.....	13
3.1 Inspection.....	13
3.2 Operation.....	14
4. Maintenance.....	30
4.1 Disposal of HU30.....	30
4.2 Cleaning and Disinfection of HU32.....	30
4.3 Cleaning and disinfection of HUV-01.....	38
4.4 Transportation.....	40
4.5 Product disposal and recycling.....	41
5. Technical Product Specification.....	42
5.1 HU Vision Specification.....	42
5.2 H Vision Specification.....	43
5.3 HUV-01 technical parameters.....	43
6. Troubleshooting.....	44
7. Appendix.....	46
7.1 List of accessories.....	46
7.2 EMC.....	47

1. Important Information – Please Read Before Use

1.1 Intended use

The Flexible Video Ureterorenoscope consists of two handles (HU Vision), disposable Flexible Ureterorenoscope HU30 and reusable Flexible Ureteroscope HU32, which are introduced within the urinary tract, and video processor (H vision) HUV-01 for clinical image processing. The device is indicated for endoscopic examination in the urinary tract, and can be used to examine the interior of the kidney, and using additional accessories, to perform various diagnostic and therapeutic procedures.

1.2 Description of intended use

The device is for use in a hospital or qualified medical institution. The HU Vision is only to be used by skilled physicians trained in clinical endoscopic techniques and procedures.

The Flexible Video Ureterorenoscope is designed for use in adults. It is indicated for endoscopic examination in the urinary tract, and can be used to examine the interior of the kidney, and using additional accessories, to perform various diagnostic and therapeutic procedures.

Endoscopic accessories that are compatible with the minimum working channel width, maximum insertion portion width and working length can be used in combination with the handle.

The minimum working channel width is 1.0 mm. It cannot be ensured that the instruments selected solely according to this minimum channel width are compatible.

The maximum insertion portion width and working length of HU30 and HU32 is 3.2 mm and 630 mm, **respectively**. It cannot be ensured that the instruments selected solely according to the maximum insertion portion width and working length are compatible.

Warning

- Do not use high-frequency electrosurgical equipment with the Ureterorenoscope, as this may result in patient injury or damage to the Ureterorenoscope.
-

Cautions

- HugeMed recommends a laser fiber (With a core diameter of 200µm or 276µm) for maximum deflection and access to the kidney. A larger fiber may break and be accidentally fired inside the working channel, damaging the endoscope.
 - HugeMed recommends using a stone extractor (with an outer diameter of 2.2 Fr or 1.9 Fr), and a zebra guide wire (with a diameter of 0.89 mm).
 - Hugemed recommends using a medical display with size of 15 inch, resolution of 1024*768.
 - Sharp accessories, such as laser fibers, can cause damage to the working channel if passed when the scope is deflected—pass these instruments only when the scope is not deflected (straight).
-

1.2.1 Absolute contraindications

1. Severe systemic hemorrhagic disease.
2. Severe cardiopulmonary dysfunction and low surgical tolerance.
3. Uncontrolled urinary tract infection.
4. Severe URETHROSTENOSIS inaccessible by endoscope.

1.2.2 Relative contraindications

1. Severe gross hematuria
2. The diameter of the ureter is too small or the ureter is narrow

1.3 Warnings, Cautions, Notes

This chapter makes a list of basic safety information that must be paid attention to and obeyed by the users when they use the Flexible Video Ureterorenoscope (“the Ureterorenoscope”). Other safety information that are same, similar or related to the specific operations will be showed in each chapter.

The following signal words are used throughout this IFU:

Warning

- Indicates a potentially hazardous situation which, if not avoided, could result in death or serious injury.
-
-

Caution

-
- Indicates a potentially hazardous situation which, if not avoided, may result in minor or moderate injury. It may also be used to alert against unsafe practices or potential equipment damage.
-

Note

- Indicates special information about operating the product, or clarifies important information.
-

1.4 Warning

Warning

- The Ureterorenoscope is used for endoscopic surgery of all kinds of ureteral calculus and parts of renal calculus, and can only be operated by professional clinicians, experts of medical electrical equipment or trained clinical medical staff in specified occasions. Personnel who operate this product shall be trained completely. Any personnel who are not authorized or not trained shall not carry out any operation.
 - The conscientious doctor must be responsible for the equipment operation procedures and technology application! The trained doctors (conscientious doctors) have the rights to decide how to fully use the equipment according to the actual application conditions.
 - Before the first use, please read the IFU carefully.
 - Before the use of the Ureterorenoscope, the user must check it and its accessories to ensure normal and safe operation.
 - Do not use the Ureterorenoscope in an environment with inflammable or explosive materials to prevent fire hazard or explosion.
 - Do not use high-frequency electrosurgical equipment with the Ureterorenoscope, as this may result in patient injury or damage to the Ureterorenoscope.
 - Properly install or carry the Ureterorenoscope and its supporting equipment to prevent falling, collision, strong vibration or mechanical damage caused by external force.
 - When the tip of the Ureterorenoscope contact the mucosa for a long time, strong light is concentrated on a small area, and the surface temperature of mucosal tissue in this area will increase due to long hours of light rays. When exceeding 41°C, burning may occur. When the Ureterorenoscope is used with its accessories, its surface temperature may exceed 41°C in a short time, with a maximum temperature of 50°C.
 - Risk of burning will increase under the following conditions:
 - Contacting mucosa at the same position for a long time;
 - Slowly injecting water into a narrow lumen;
 - The following methods shall be taken to reduce the risk of burning:
 - Avoid contacting mucosa at the same position for a long time as far as possible.
 - Turn off the lighting source after use to prevent accidents.
 - Electromagnetic field will affect the performance of the Ureterorenoscope and its supporting equipment. Therefore, equipment used near the Ureterorenoscope and its supporting equipment must conform to the corresponding EMC requirements; otherwise
-

 **Warning**

faults or breakdown of the Ureterorenoscope may occur due to electromagnetic interference. Mobile phone, X ray or MRI equipment are possible interference sources, and can produce high-intensity electromagnetic radiation.

- All other equipment, for example, some similar digital interference equipment, must conform to relevant requirements in the detailed standards (such as the requirements of IEC 60950-1 on digital processing equipment and the requirements of IEC60601-1 on electrical equipment) when connecting to the Ureterorenoscope. In addition, when additional equipment is connected to the Ureterorenoscope, involving equipment signal input and output, its structure must conform to the system structure in accordance with IEC60601-1. The personnel responsible for connecting the equipment must ensure system operability and complete compliance with the system requirements. If there is any other problem, please consult the local equipment supplier or HugeMed's technical service center.
 - HU30 is a single-use device and must be handled in a manner consistent with accepted medical practices for such devices in order to avoid contamination of the Ureterorenoscope prior to insertion.
 - Do not attempt to clean, sterilize, and reuse HU30 on another patient as it is a single-use device, **the re-use may be lead infection.**
 - After using HU32, reprocess and store it according to the instructions given in 4.2 Cleaning and Disinfection of HU32. Using improperly or incompletely reprocessed or stored instruments may cause patient cross-contamination and/or infection.
 - HUV-01 must not be used as an independent diagnostic tool of any pathology. Physicians must interpret and substantiate any findings by other means and in light of the patient's clinical characteristics.
-
-

1.5 Caution

Caution

- Use environment and power supply of the Ureterorenoscope must conform to Chapter 5 *Technical Product Specification*.
 - Repair or upgrade of the Ureterorenoscope must be carried out by the maintenance personnel trained or authorized by HugeMed.
 - Relevant local laws and regulations and the hospital's waste treatment system must be followed when disposing of packing materials.
 - HugeMed will not bear responsibilities for any personnel injury and property loss due to the following reasons:
 - Equipment parts are not original to HugeMed;
 - Missing of Instructions for use;
 - Installation, commissioning, modification, upgrade and maintenance are not carried out by the personnel authorized by HugeMed.
 - HugeMed will not bear responsibilities for those damages or events caused by use of consumables or accessories not provided by HugeMed.
-

1.6 Note

Note

- Please keep this IFU beside the Ureterorenoscope for convenient and timely reference as needed.
 - This IFU introduces the product with the most complete configuration and functions, and the product you purchased may have no certain configurations or functions.
-

2. System Parts

Warning



- If combinations of equipment other than those shown below are used, the full responsibility is assumed by the medical treatment facility.
-





Caution

- Some faults can be eliminated in accordance with chapter 6 “Troubleshooting”. If problems persist after operations have been performed in accordance with chapter 6, please contact Hugemed. The system can only be repaired by a specialist authorized by HugeMed.
-

2.1 System chart

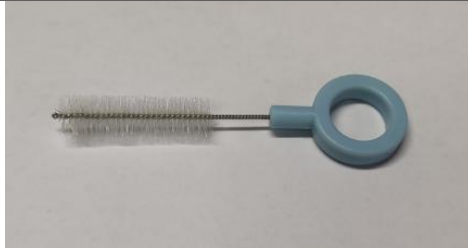
Table 2-1 System Chart

HU Vision	Model /Part
	HU30
	HU32

		<p>Cleaning brush</p>
		<p>Short bristle brush</p>
		<p>Leak detector</p>
		<p>Water-resistant cap</p>
<p>H Vision</p>	<p>Model /Part No</p>	
	<p>HUV-01</p>	

		<p>Equipotential line</p>
		<p>Power cord: Europe configuration</p>
		<p>Power cord: China configuration</p>
		<p>Power cord: USA configuration</p>

Note

- The power plug supplied with the device may differ from those in this figure as the cables sold in every country should be in compliance with local applicable standards.
-

2.2 Description of the System

The Flexible Video Ureterorenoscope consists of two handles (HU Vision) – disposable Flexible Ureterorenoscope HU30 and reusable Flexible Ureteroscope HU32, which are introduced within the urinary tract. And the video processor (H vision) HUV-01 is for clinical image processing.

2.2.1 Description of handle HU30

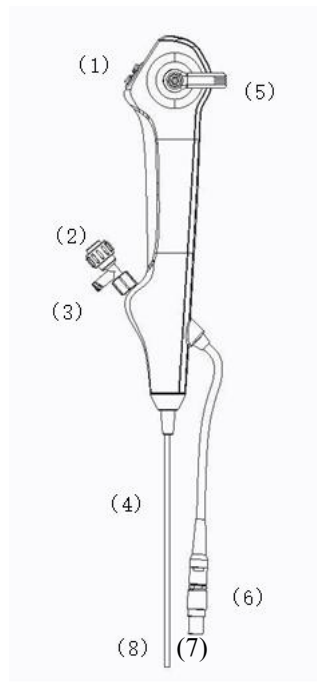

- (1) Button: It is used for picture taking, video recording, image freezing and white balance.
- (2) Instrument channel port: It is used for inserting the spare part of therapeutic endoscopy.
- (3) Luer taper port: It is used for connecting the lavage system.
- (4) Insertion part.
- (5) Manual lever: Move the lever forward and backward to control the bending direction and angle of the bending part.
- (6) Cable connector: It is used to transmit the image data to the host.
- (7) Tip part.
- (8) Controllable bending part.

2.2.2 Description of handle HU32

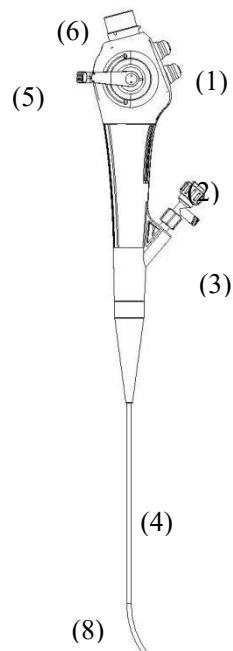

- (1). Button: It is used for picture taking, video recording, image freezing and white balance.
- (2). Instrument channel port: It is used for inserting the spare part of therapeutic endoscopy.
- (3). Luer taper port: It is used for connecting the lavage system.
- (4). Insertion part
- (5). Manual lever: Move the lever forward and backward to control the bending direction and angle of the bending part.
- (6). Signal connection line joint: transfer image data to the host.
- (7). Tip part
- (8). Controllable bending part

2.2.3 Description of image processor HUV-01

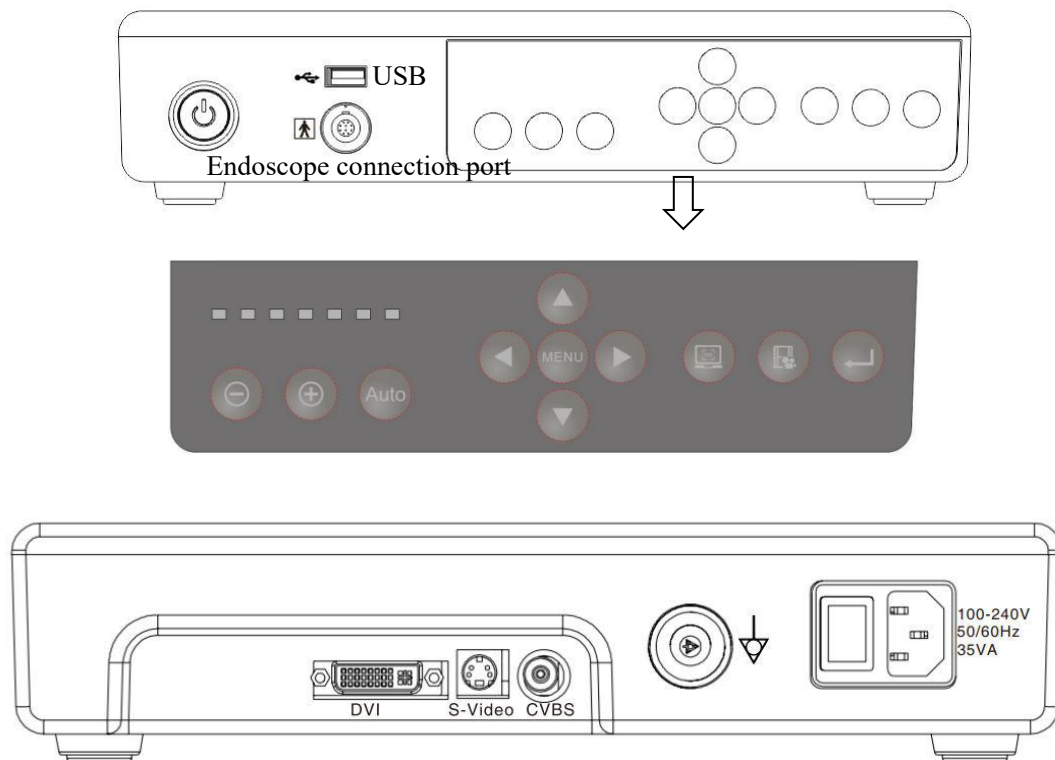





















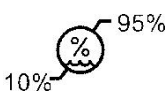
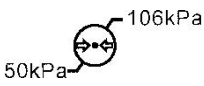









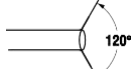

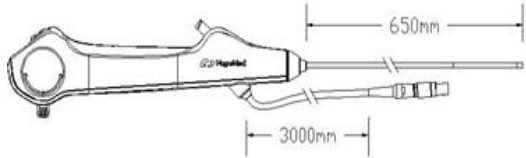

Table 2-2 Function of buttons

Button	Power button	Returning/confirmation button	Video button	Freezing button/ Camera button	White balance button	Menu button	Auto	+	-
Logo									
Function	Turn on / off the power	Exit the menu setting interface/ confirm the operation	Save the video	Freeze and save image	White balance function	Enter the menu setting	Switch the light output set value and custom value	Increase the light output	Decrease the light output

2.3 Explanation of Symbols Used

	CE Mark		EC Authorized Representative
	Attention/Be careful/Warning		Type II equipment
	BF application component		Please read the instructions for use
	Power adapter (AC)		Use-by date
	Batch number		Serial number
	Manufacturer		Production date
	Pollution-free disposal		Scope of humidity of transported package: 30%–95%
	Scope of environment pressure of transported package: 70–106 kPa		Scope of temperature of transported package: 0–45°C
	Fragile materials inside, handle with care		Protect from moisture
	Face up during transportation		Maximum 5 layers stacked with same package
	Prescription Device		Sterile product EO sterilization
	Disposable product. Do not reuse.		Latex free natural rubber
	Do not use if package is damaged.		Range of view angle
	Maximum width of insertion part (maximum outer diameter)		Minimum width of working channel (minimum outer diameter)
		Working length	

3. Inspection and Operation

3.1 Inspection

Warning

- The software copyright of HUV-01 host belongs to the company. It shall not be tampered, copied or exchanged by any organization or individual in any form or by any means without permission.
-

Note

- The electronic form of this instruction for use can be uploaded from the website of Hugemed: <http://www.hugemed.net/en/index.php?id=92>
-

3.1.1 Out-of-box inspection

Before unpacking, please check the packaging box carefully to determine whether the product is damaged during transportation. If any damage is found, please immediately contact the carrier or our company.

If the packaging is intact, please properly unpack the package, carefully take out the HU32 handle, HUV-01 host and other components, and count them one by one according to the packing list. Check the product for any mechanical damage and the completeness of items. If you have any questions, please immediately contact our after-sales service department.

Warning

- Users should place the packaging materials out of the reach of children. When handling packaging materials, you must comply with relevant local regulations or waste disposal system of the hospital.
-

Cautions

- Please well keep the packing box and packing materials for convenience of later transportation or storage.
 - If some accessories are missing when you open the package, please contact the dealer or manufacturer who sold this product to you as soon as possible.
-

3.1.2 Environmental requirements

The use environment of the H Vision and HU Vision should meet the requirements of *Chapter 5*

Technical Product Specification.

The use environment of the H Vision and HU Vision should also avoid the existence of noise, vibration, dust, corrosive, or flammable and explosive substances, etc.

When the H Vision and HU Vision are transferred from one environment to another, there may be condensation on the Ureterorenoscope due to differences in temperature or humidity. At this time, it should not be started until the condensation disappears.

3.1.3 Power requirements

The power supply used by the H Vision and HU Vision should meet the requirements of **A.3 Power Specifications**.

Warning

- Please ensure that the H Vision and HU Vision work under the specified environmental requirements and power requirements; otherwise they will not meet the technical specifications claimed in *Chapter 5 Technical Product Specification*, and may cause unpredictable consequences such as invalidation of the H Vision and HU Vision.
 - Choose the proper power supply according to the setting of the power voltage of the H Vision and HU Vision; otherwise it may cause serious damage to the device.
-
-

3.2 Operation

Warning

- Before using this device, please read the Instructions for use attached to the host. The host and handles belong to one system.
 - An image generated from the HU Vision must not be used as an independent diagnosis of any pathology. Physicians must make the diagnosis through other means and according to the clinical characteristics of the patient.
 - HU Vision can only be used by skilled physicians who have been trained in clinical endoscopic techniques and procedures.
 - Please clean and disinfect the HU32 after use since it is a reusable device.
 - Endoscope accessories with correct size must be selected. However, it cannot be ensured that the endoscope accessories selected according to the minimum diameter of the HU Vision instrument channel are compatible.
 - It cannot be ensured that the endoscope accessories selected according to the maximum diameter and length of the insertion part of the HU Vision are compatible.
 - Before use, be sure to check the appearance and function of the device. If any problems are found, please do not use this system.
-
-

Warning

- The plugs of H Vision and the HU Vision have alignment marks. Pay attention to the direction of the connector when inserting. Do not forcibly insert for connection, the plug may be damaged if the position is not aligned.
- Do not use excessive force when operating the HU Vision.
- Always watch the live endoscopic image on the screen when advancing or withdrawing the operable and controllable portion of the HU Vision.
- Do not install and operate the system in the following locations where explosion and fire may occur if the system has no explosion-proof function.
 - The oxygen concentration is very high.
 - There is oxidant (such as nitrous oxide (N₂O)) in the air.
 - There are flammable anesthetics in the air.
 - There is flammable liquid nearby.
- Do not apply excessive force when operating the HU Vision.
- When the H Vision is inside the patient, do not disconnect it from the HU vision.
- If any malfunction occurs during the endoscopic procedure, please stop the procedure immediately. Make sure that the marker on the deflection wheel/lever is aligned with the mid-position indicator on the handle so that the controllable portion is in a straight position. And slowly withdraw the insertion cord without touching the deflection wheel/lever.

Always watch the live endoscopic image on the screen when advancing or withdrawing the insertion cord, or when operating the controllable portion.

Cautions

- When using sharp devices with the HU Vision, please be careful not to damage the insertion part and the tip.
 - Handle the tip of the insertion part with care, and avoid contact with other objects; otherwise it may damage the device, the fragile lens surface of the tip and cause image distortion.
 - Do not apply excessive force to the controllable bending part; otherwise the device may be damaged. Examples of improper handling of controllable bending part include:
 - Manual bending
 - Operate the manual lever in any situation where resistance is felt.
 - It is recommended to use 200-micron laser fiber to achieve the best steering angle of the controllable bending part into the kidney. Large-diameter fiber may pierce the channel of the ruptured instrument, and the high-energy laser is directly emitted inside the endoscope, thereby damaging the endoscope.
 - It is recommended to use a Stone Retrieval with an outer diameter of 2.2 Fr or 1.9 Fr and a zebra urological guide wire with a diameter of 0.89 mm.
-
-

Cautions

- If sharp endoscope accessories such as laser fiber optics pass through when the soft lens bends and turns, it may cause damage to the instrument channel. Only when HU Vision insertion part and the controllable bending part are in a straight state can the instrument channel pass through these sharp endoscope accessories.
 - Keep the handle dry during preparation, use and storage.
-

3.2.1 Operation of HU30

The system shall be used in hospitals or qualified medical institutions. The HU30 is intended for use only by skilled physicians trained in clinical endoscopic techniques and procedures.

Warning

- Do not use HU30 if the product sterilization barrier or its packaging is damaged.
 - The HU30 is sterilized by EO. Pay attention to the expiry date of sterilization on the labels. Do not use if the product has already expired.
-

1. Keep patients ready as the standard procedures before surgery

Properly connect the HU30 according to the instructions attached to the H Vision before the host is powered on and started. Inspect and prepare the host first before pressing the power switch to start it.

2. Handling of device after surgery

After use, it is necessary to turn off the power switch of the host before removing the HU30 from it; otherwise, the host may get damaged.

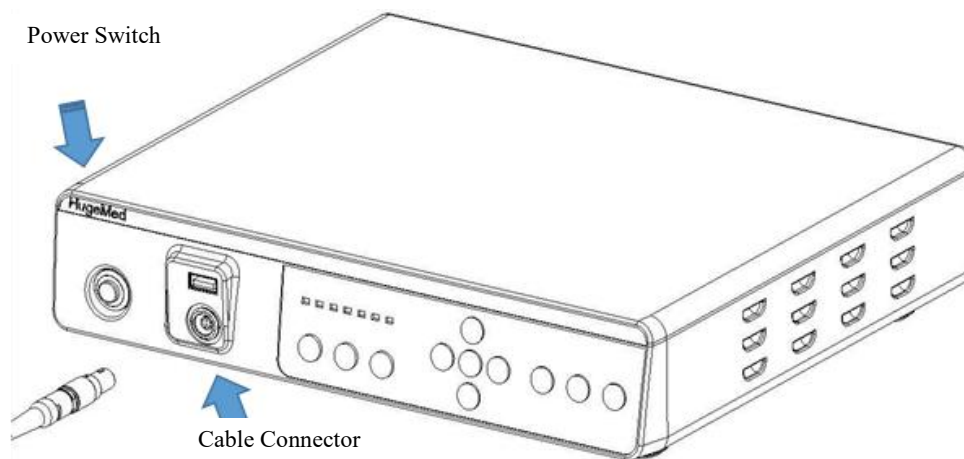

【Fig. 3-1】 Connection of HU30 and HUV-01

3. Hold the HU30 by either hand (left hand is recommended), control the manual lever with the thumb, and insert the insertion part into the patient's body by another hand.

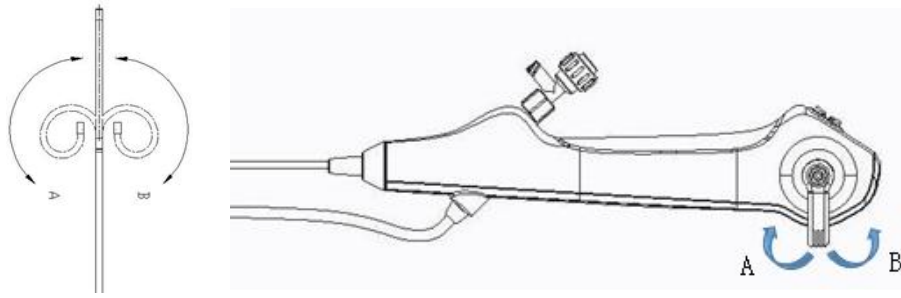

【Fig. 3-2】 Bending direction of HU30

The bending direction and angle of the controllable bending part of the HU30 can be controlled with the manual lever. The tip end will bend up (A) if the manual lever is slide to the position “U”, and down (B) if it is slide to the position “D”.

It is recommended to apply medical-grade water-soluble lubricant to the surface of the insertion part to reduce the friction when the HU30 is inserted into the patient’s body.

⚠ Warning

- When the HU30 is inserted, the controllable bending part must be in a straight state. Do not operate the manual lever at the same time, as this may result in patient injury and damage to the HU30.
 - If the image of HU30 becomes unclear, you can cover the tip part with lavage fluid to clean the lens, or wipe the tip part with a sterile gauze or hospital-grade disinfection cloth. Repeat this process until a clear image is obtained.
-

4. Connect the injection syringe or injection pipe connector to the Luer taper port on the handle. Inject liquid (normal saline) via the Luer taper port.

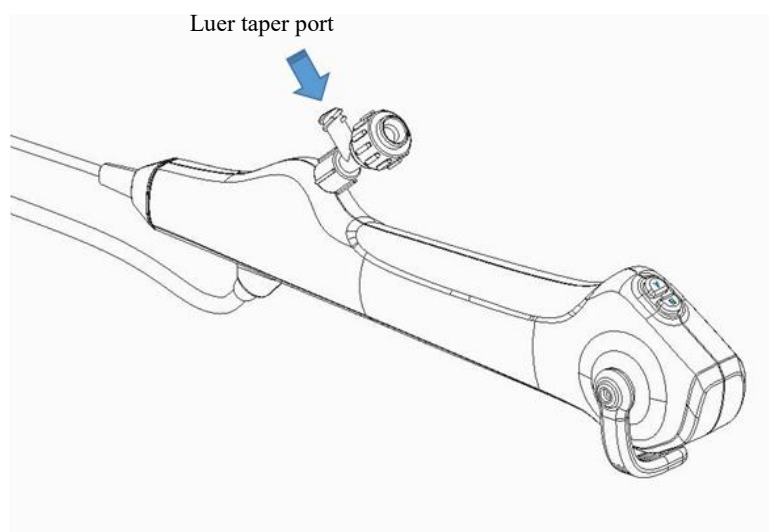

【Fig. 3-3】 Connecting the injection syringe

Cautions

- Set minimum pressure and flow rate shall be maintained to avoid high pressure in the kidney and excessive absorption of lavage fluid when perfusing the liquid during the surgery. The recommended pressure is 40-75 mmHg.
 - If the endoscope accessory is placed in the instrument channel, the flow rate of the lavage fluid will be reduced.
-
-

5. Insert the endoscope accessory via the instrument channel opening, and carefully push it through the instrument channel until it is displayed on the host.

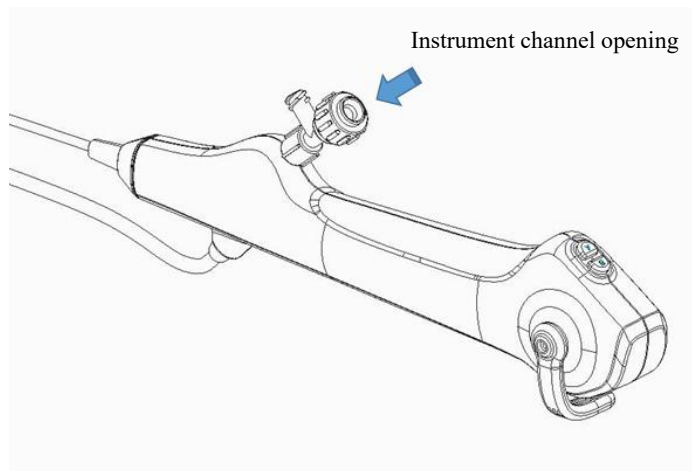

[Fig.3-4] Insert the endoscope accessory

Cautions

- Do not advance or withdraw the endoscope when the endoscope accessory is protruding from the instrument channel at the tip part, as this may cause injury to the patient.
 - When inserting or withdrawing the endoscope accessory in the instrument channel, ensure that the mark on the manual lever is aligned to the mark on the handle, and the controllable bending part is in a straight state. Do not exert excessive force when advancing or taking out the endoscope accessory in the working channel.
 - Always ensure to select the endoscope accessory of correct size (see Instructions for Endoscope Accessory).
 - Inspect the endoscope accessory before use. If its appearance or function is poor, please replace it.
-
-

6. When taking out the HU30, ensure that the mark on the manual lever is aligned to the mark on the handle, and the controllable bending part is in a straight state. Slowly take out the HU30 from the patient's body while watching the real-time image on the host.
-

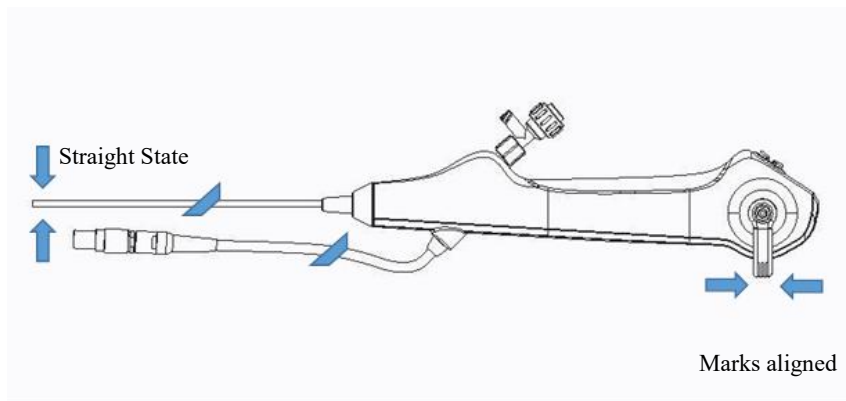

[Fig. 3-5] Controllable bending part in a straight state

⚠ Warning

- When removing the HU30 from the patient's body, the controllable bending part must be in the straight state. Do not operate the manual lever at the same time, as this may result in patient injury and damage to the HU30.
- If the HU30 is used in the same patient for several times during the same surgery, it shall be kept in a sterile state between the first operation and the last operation to prevent potential contamination.

Caution

- When operating the HU30, do not touch the patient with the tip part for over 1 minute, as the temperature of the tip part may cause discomfort to the patient.

3.2.2 Operation of HU32

The system is used in hospitals or qualified medical institutions. HU32 is intended for use by skilled physicians who have been trained in clinical endoscopic techniques and procedures.

2. Keep patients ready as the standard procedures before surgery

Connect HU32 according to the instructions attached to the host. Inspect and prepare it before pressing the power switch to start the host.

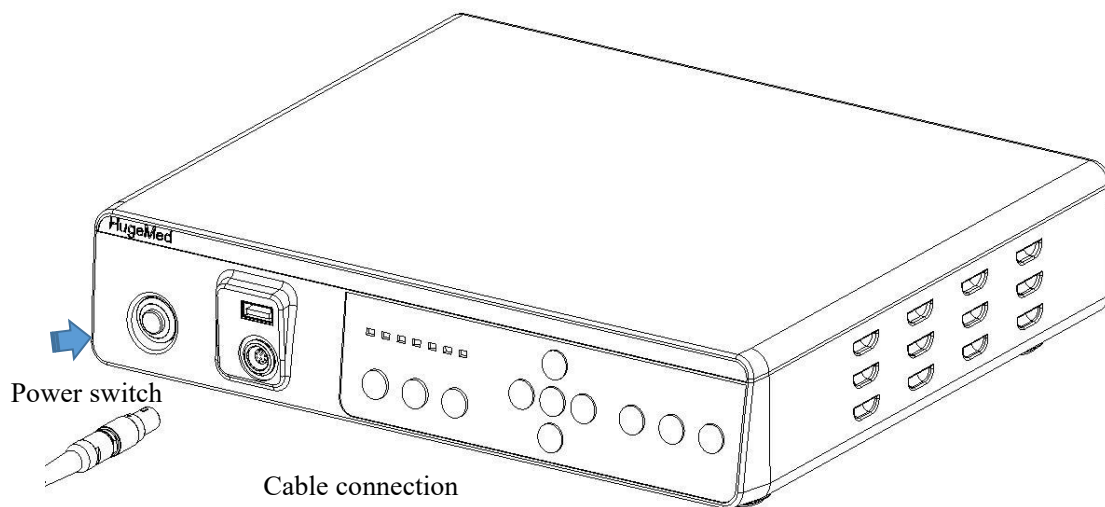

【Fig. 3-6】 Connection of HU32 and HUV-01

3. Hold the HU32 with either hand, control the manual lever with the thumb, and insert the insertion part into the patient with the other hand.

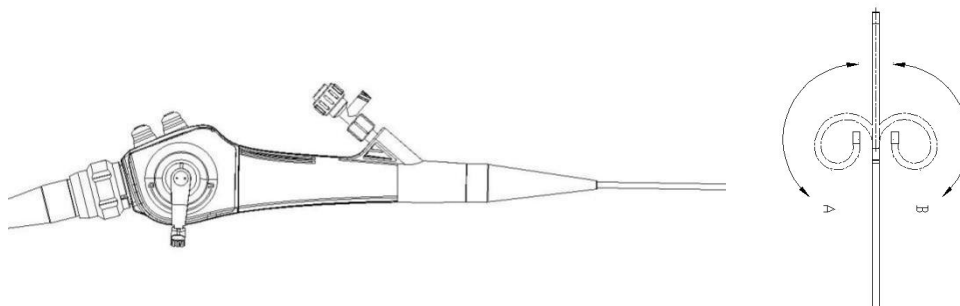

【Fig. 3-7】 Bending direction of HU32

The bending direction and bending angle of controllable bending part of HU32 can be controlled by manual lever. Sliding the manual lever to the position "U" will cause the tip to bend upward (A). Sliding it to "D" will cause the tip to bend downward (B).

It is recommended to apply medical grade water-soluble lubricant to the surface of the insertion part to reduce the friction when HU32 is inserted into the patient.

⚠ Warning

- When inserting HU32, the controllable bending part must be in a straight state. Do not operate the manual lever at the same time, as this may cause patient injury and damage to the HU32.
 - If the image of HU32 becomes unclear, you can cover the tip with lavage fluid to clean the lens, or wipe the tip with a sterile gauze or hospital disinfection cloth. Repeat this process
-

until a clear image is obtained.

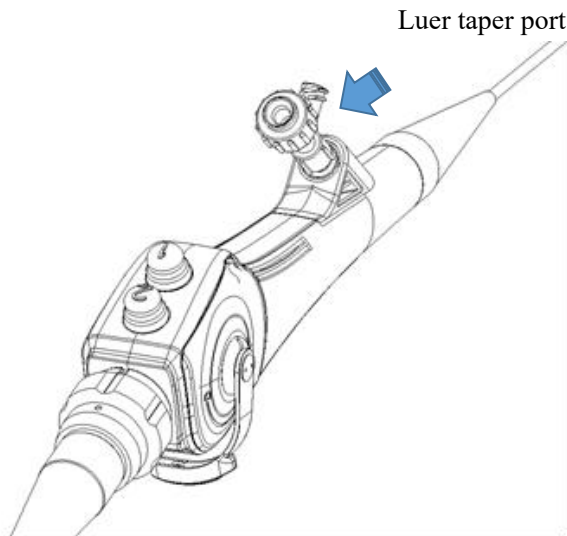

【Fig3-8】 Connecting the injection syringe

3. Connect the syringe or syringe connector to the Luer taper port of the handle. Inject liquid (normal saline) through the Luer taper port.

Cautions

- Set minimum pressure and flow rate should be maintained to avoid high pressure inside the kidney and excessive absorption of lavage fluid when perfusing the liquid during the surgery. The recommended pressure is 40-75 mmHg.
 - If the endoscope accessories are placed in the instrument channel, the flow rate of the lavage fluid will be reduced.
-
4. Insert the endoscope accessory into the instrument channel port and carefully push it through the instrument channel until it can be seen on the host.

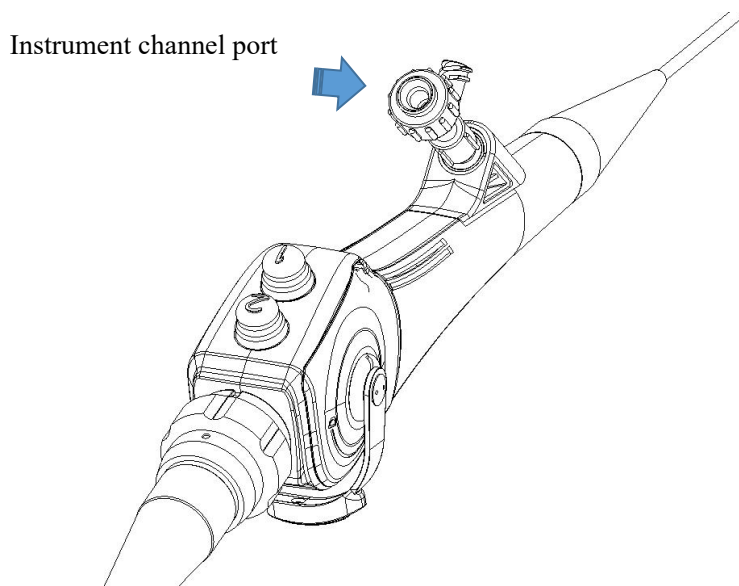

【Fig. 3-9】 Insert the endoscope accessory

⚠ Warning

- When the endoscope accessory is protruding from the instrument channel at the tip, do not advance or take out the endoscope, as this may cause injury to the patient.
 - When inserting or taking out the endoscope accessory in the instrument channel, ensure that the mark on the manual lever is aligned with the mark on the handle, and the controllable bending part is in a straight state. Do not use excessive force when advancing or taking out the endoscope accessories in the working channel.
-

Always make sure to choose the endoscope accessory of correct size (please refer to Instructions for Endoscope Accessory).

Check the endoscope accessories before use. If its appearance or function is poor, please replace it.

5. When taking out the HU32, make sure to align the mark of the manual lever with the mark on the handle, so that the controllable bending part is in a straight state. Watch the real-time image on the host and slowly take out the HU32 from the patient.

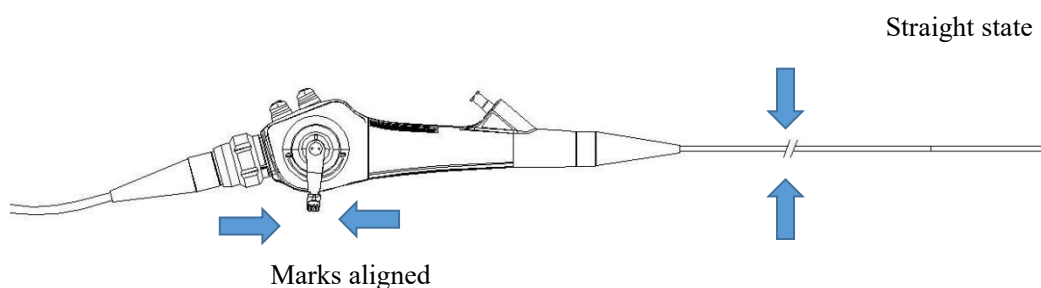

【Fig. 3-10】 Controllable bending part in a straight state

Warning

- When taking out the HU32 from the patient, the controllable bending part must be in a straight state. Do not operate the manual lever at the same time, as this may cause injury of patient and damage to the HU32.
-

Note





- When operating the HU32, do not touch the patient with the tip part for over 1 minute, as the temperature of the tip may cause discomfort to the patient.
-



3.2.3 Operation of HUV-01

USB flash drive is the only interface that can exchange data with the outside.

Warning

- You must use a USB flash drive provided by Hugemed. At the same time, the connection between the USB flash drive and the host is encrypted.

When entering the home screen mode, a red dot appears in the upper left corner of the display, and the USB flash drive is detected. After about 5 seconds, the red dot turns into a green dot, the image processor host detects the USB flash drive and prompts you to enter the password. through the host panel, press keys  and , enter 0000 in turn, press  confirm, and press  again to exit the password interface, you can store real-time photos or videos in the U disk.

Click  to increase the light output of the HU32 handle, click  to decrease the light output of the HU32 handle, click  to switch the set value and custom value of the light output (set value: factory set value is the fourth gear, custom value: set by the user as needed).



3.2.4 Home screen interface

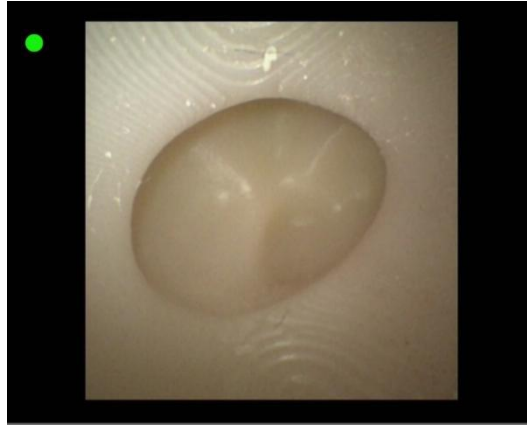

Press the power button  to start HUV-01. At this time, the power button will light up and the system automatically enters the home screen mode, as shown in 『Fig. 3-11』 .





【Fig. 3-11】 Home screen interface

(1) When the host is connected to a U disk or mobile hard disk, a green dot will be displayed in the upper left corner of the screen; if no U disk or mobile hard disk is connected, the green dot will not be displayed, and the host will not do any processing, thus there is no display on the interface.

(2) Camera: In the home screen mode, click the camera button  on the control panel, and a freeze prompt  will appear in the lower left corner of the screen. Meanwhile, a red circle will flash around the green dot in the upper left corner of the screen to prompt that the image has been saved. The images and videos saved will be named by time.

(3) Video recording: When the video recording button  on the control panel is clicked, the green dot on the upper left corner of the screen will flash. At this time, the video recording has been started. To end the video recording, re-click the video recording button  on the panel again, the screen will prompt that the video has been saved. The images and videos saved will be named by time.

The

(4) Freezing: In the home screen mode, click the camera button  on the control panel, and a freezing prompt  will appear in the lower left corner of the screen, and the real-time image has been frozen. Meanwhile, a red circle will flash around the green dot in the upper left corner of the screen, prompting that the image has been saved. The images and videos saved will be named by time.

(5) White balance: Align the tip to the white reference object, press the white balance button  on the control panel, and the color of the image displayed on the screen will return to normal after the white balance is completed,.

(6) Click the menu setting button  on the control panel to enter the main menu mode, as shown in 『Fig. 4-3』 .



3.2.5 Main interface menu mode

- 1) Color mode: preset three modes of M0, D65, LED1.
- 2) Red Saturation: Adjust the value of the red color in the image.
- 3) Green Saturation: Adjust the value of the green color in the image.
- 4) Blue Saturation: Adjust the value of the blue color in the image.
- 5) AGC type: Mean extinction or peak extinction can be selected. The mean extinction mainly refers to the average brightness of the whole image for extinction, while the peak extinction mainly refers to the number of overexposure points for extinction.
- 6) Sharpness: Adjust the image resolution and edge sharpness. The higher the value, the more acute the image and the higher the noisy point.
- 7) 3D denoise: Reduce the image noise. The higher the value, the stronger the noise reduction is. "0" means the noise reduction function is not activated.
- 8) Gamma level: Adjust the contrast of the image. The higher the value, the higher the contrast.
- 9) Magnification: Value 0 means that the image is not amplified. Value 1 and value 2 are options. See 4.1.5 Image magnification settings.
- 10) Frame: Value 0 is the default frame. Values of 1-6 are available to choose. See 4.1.4 Frame switching settings.
- 11) Record source: Select a source from HU32 images to external video input images.
- 12) CVBS mode: Choose PAL system or NTSC system.
- 13) Language: Chinese or English can be switched in real time.



【Fig. 3-12】 Main interface menu mode

3.2.6 Frame switching settings

- (1) Frame switching operation is allowed in the main interface menu mode. Click the down button  to select the frame options; click the right button , and the image frame is shown as 【Fig. 3-13】 .

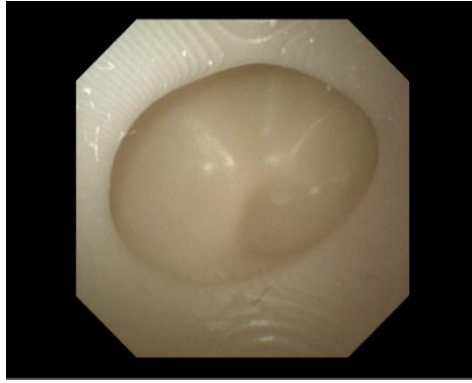

【Fig. 3-13】 Frame 1

- (2) Click the right button , and the image frame is shown as **【Fig. 3-14】** .

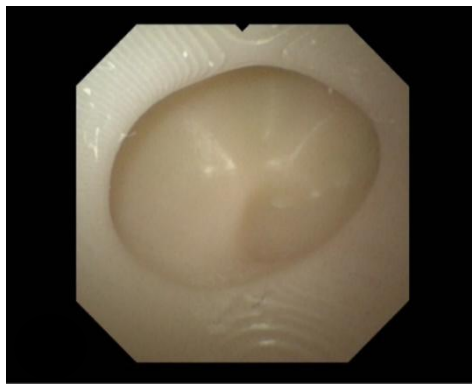

【Fig. 3-14】 Frame 2

- (3) Click the right button , and the image frame is shown as **【Fig.3-15】** .

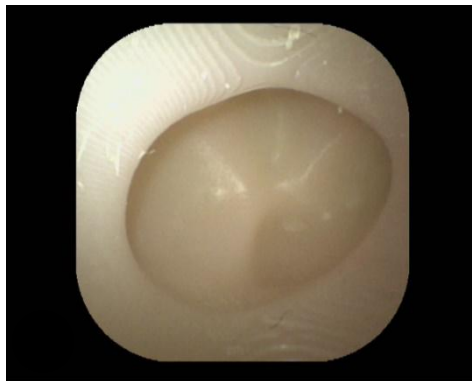

【Fig.3-15】 Frame 3

- (4) Click the right button , and the image frame is shown as

[[Fig.3-16]]



[[Fig. 3-16] Frame 4

(5) Click the right button , and the image frame is shown as [[Fig.3-17]].

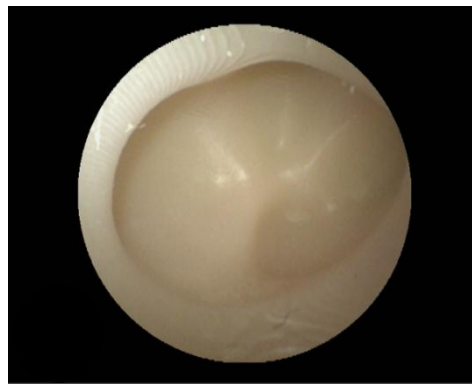

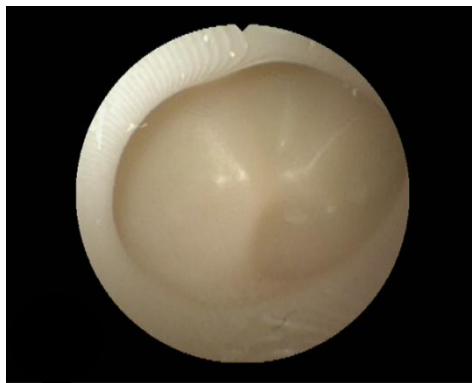

[[Fig. 3-17] Frame 5

(6) Click the right button , and the image frame is shown as [[Fig.3-18]].



[[Fig. 3-18] Frame 6

3.2.7 Image amplification settings

(7) The amplification and switching operations are allowed in the main menu mode. Click the down button  to select the amplification options. Click the right button , and the image amplification is shown as [[Fig. 3-19]].



【Fig.3-19】 Amplification 1

(8) Click the right button , and the image amplification is shown as 『Fig. 3-20』 .

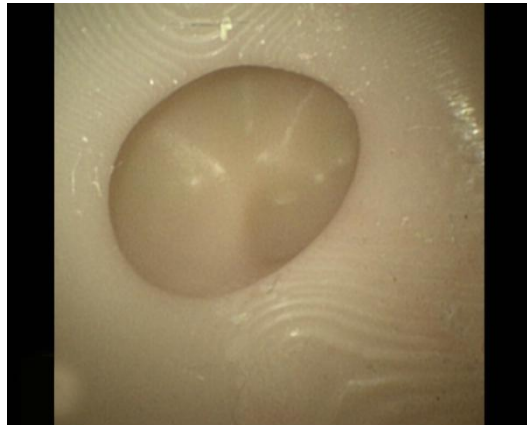



【Fig.3-20】 Amplification 2

3.2.8 Language settings

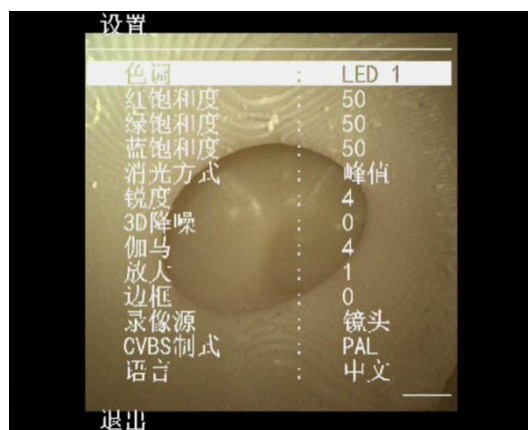
(9) The default language is Chinese as shown in 『Fig. 3-12』 .



【Fig. 3-21】 Chinese mode

(10) The language switching operation is allowed in the main interface menu mode. Click the down button  to select the language options. Click the right button , and the language is set as shown in [Fig. 3-22] .

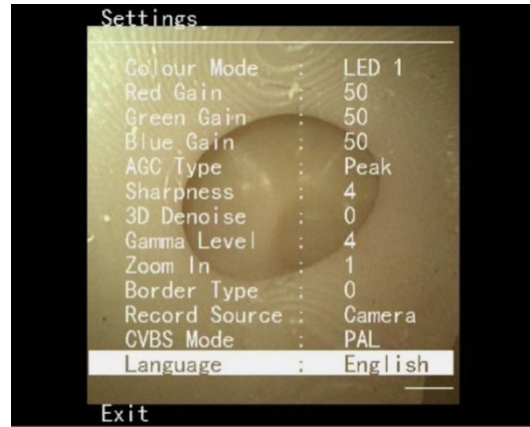

[Fig. 3-22] English mode

4. Maintenance

The HU30 is supplied in a sterile state, and disposable only.

The HU32 handle and HUV-01 host (H Vision) are reusable. Maintenance should be done after daily use.

Warning

- Hospitals or medical institutions that use the HU32 handle and HUV-01 host should establish a complete maintenance plan; otherwise it may cause equipment failure and other unpredictable consequences, and endanger the safety of patients and equipment users.
 - If HU Vision and the H Vision are abnormal, it is forbidden to use, please contact the dealer or manufacturer who sold this product to you as soon as possible.
 - The safety inspection or maintenance of HU32 handle and HUV-01 host should be performed by professional maintenance personnel designated by HugeMed. The operation of professional maintenance personnel not designated by HugeMed may cause equipment failure and endanger the safety of patients and equipment users.
 - Before the equipment is repaired, it must be cleaned and disinfected.
-
-

4.1 Disposal of HU30

If HU30 is deemed as being contaminated after being unpacked and used, it must be collected and disposed of as medical waste with electronic components in accordance with local disposal procedures and criteria for medical wastes.

4.2 Cleaning and Disinfection of HU32

Warning

- Use only the materials and methods listed in this chapter to clean or disinfect the Ureterorenoscope. The Company shall not be liable for any damage or accident caused by the use of other materials or methods.
 - The chemicals or methods listed by our company are only used as means to control infection, and our company does not assume any responsibility for their effectiveness. Consult your hospital's infection prevention department or an epidemiologist about ways to control infection.
 - Please ensure that HU32 is kept in a dust-free environment. To prevent damage to HU32, the following regulations must be observed:
 - The waterproof joint must be installed before the whole machine is immersed during cleaning and disinfection;
 - Before immersion disinfection, the sealing test must be carried out as required. If any leakage is found, do not soak it;
-
-

-
- Do not use abrasive materials (such as steel wool or silver polishing agent) and solvents similar to xylene and acetone to clean HU32, so as to avoid damage to HU32.
-

Clean and disinfect the handle of HU32 according to the following procedures:

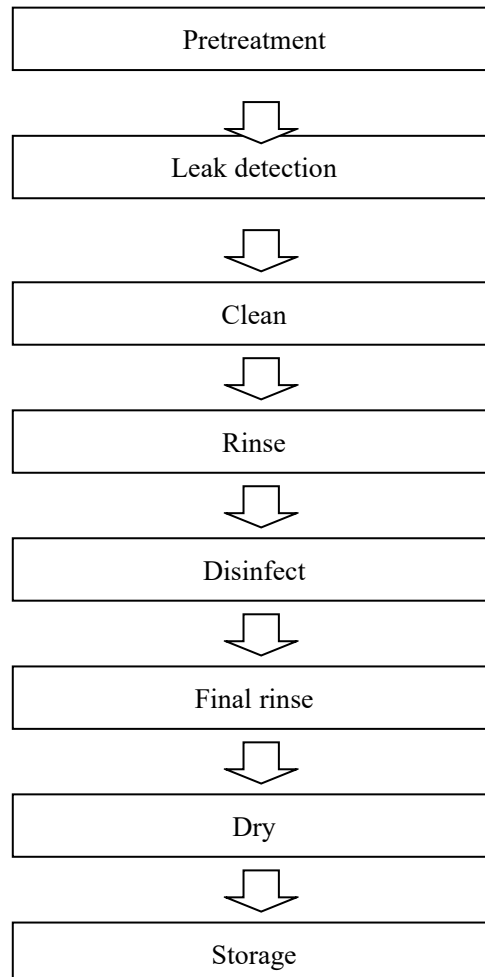

4.2.1 Pretreatment

1. After HU32 is removed from the patient's body and detached from the image processor, the external surface dirt should be erased immediately with a wet towel or wet gauze containing the cleaning fluid. The wet towel or wet gauze should be used once;
2. Install T type valve: connect external suction pump and put the tip part of the endoscope into a container with cleaning liquid. Start the suction function, draw the cleaning liquid for 30 s, remove the tip part from the cleaning liquid, and press the suction button to attract air for 10 s;

★Attention: During the process of suction, carefully observe the liquid in the suction bottle to avoid damage to the suction pump due to liquid overflow;

3. Turn off the suction pump;
4. Remove the suction hose from the endoscope, disconnect the endoscope from the image processor, and remove the T-valve from the endoscope.

5. Install the leak detector. Place HU32, suction hose and T-valve into the delivery container and send them to the cleaning and disinfection room.

4.2.2 Leak detection

★ *Note: Before leak detection, visually inspect the endoscopic surface. In case of corrosion, pitting corrosion or seal rupture, stop the leak detection immediately and contact the after-sales service department of our company.*

This product is a full waterproof endoscope, which can be soaked, cleaned and disinfected. However, the sealing of the whole machine should be checked according to the following steps before soaking.

1. Connect the leak detector as shown in (Fig. 4-1).

★ *Note: Before leak detection, the aviation plug of HU32 must be sealed with the waterproof connector, otherwise the Flexible Video Ureterorenoscope will be damaged.*

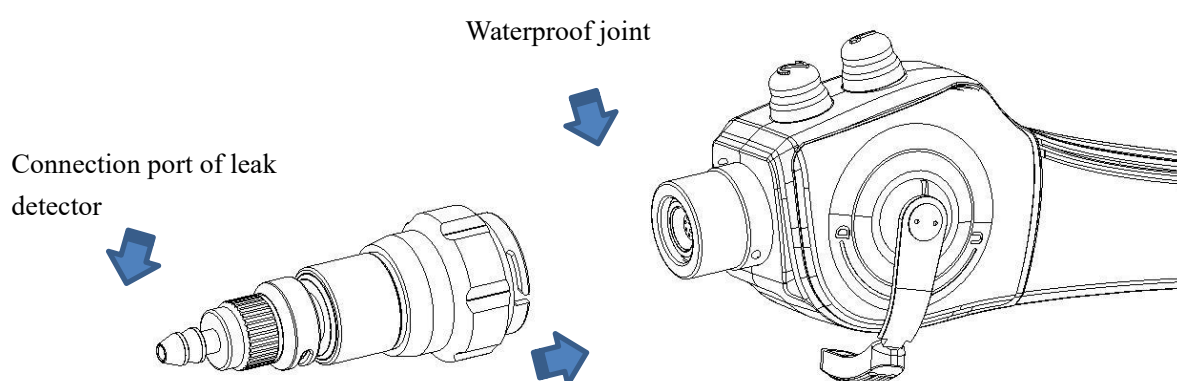

[Fig. 4-1] Installation diagram of HU32 leakage detection

2. As shown in Fig. 4-1, connect the leak detector to the waterproof joint after installing the waterproof joint of HU32,

3. Pressurize the leak detector to 24 Kpa, and then stop to observe whether the pointer index on the leak detector drops.

4. If the index of the pointer drops slowly, the pressure should be continued slowly, but it should not exceed 24 Kpa; otherwise HU32 will be damaged. At the same time, put the endoscope into water to check whether there are continuous bubbles on the surface of the endoscope. If bubbles keep coming out, implying a leakage at this site, immersion cleaning or disinfection cannot be

carried out anymore. Stop soaking, cleaning, disinfection, or use, and contact HugeMed after-sales service department immediately for solution.

5. If there is no change in the pointer index of the leakage meter, it indicates that the sealing performance of HU32 is good, and the instrument can be used, soaked, cleaned and disinfected normally.

4.2.3 Cleaning

★ *Note: If it is observed that the instrument is not completely cleaned at the end of the cleaning procedure, the cleaning procedure should be repeated.*

1. Put the cleaning agent into a cleaning tank according to the temperature and concentration recommended by the detergent manufacturer, and completely immerse the endoscope, button and manual lever in the cleaning solution.

Metrex EmPower cleaning agent at a concentration of 1:128 is recommended for use. The recommended cleaning temperature is 20°C-40°C, and soaking time is not less than 1 minute;

2. Wipe the mirror body and manual lever repeatedly with a lint free cloth, especially the insertion part and operation part. The lint free cloth should be replaced after use;

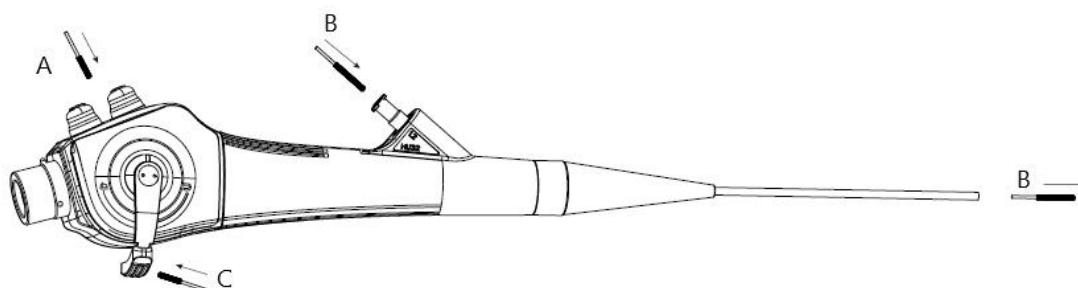

【Fig. 4-2】 Cleaning

3. Brush the clamp channel, clamp port, button seat, manual lever and T-valve (as shown in Fig. 4-3-3) according to the following steps:

★ *Note: The cleaning brush should not move reversely in the middle of the process. Only when the brush head is completely exposed from the top can it be pulled out reversely, so as to avoid damage to the inner wall of the pipe.*

Brush clamp

a. As shown in Fig. 4-2, B, insert the cleaning brush into the clamp port and slowly advance it until the brush head extends from the tip part;

- b. Clean the bristles with your fingertips in the cleaning solution, and then carefully pull out the cleaning brush from the clamp port through the pipe;
- c. Clean the bristles with fingertips in the cleaning solution again;
- d. Repeat 9 times until all debris is completely removed.

Brush clamp port

- a. As shown in Fig. 4-2, B, insert the short bristle brush from the clamp port of the operation part until the brush handle contacts the clamp port.
- b. Rotate the brush once.
- c. Withdraw the brush and clean the bristles with your fingertips in the cleaning solution.
- d. Repeat 9 times until all debris is completely removed.

Brush button seat and button

- a. As shown in Fig. 4-2, A, insert the short bristle brush from the button seat until half of the brush is inserted into the suction button seat.
- b. Rotate the brush once.
- c. Withdraw the brush and clean the bristles with your fingertips in the cleaning solution.
- d. Repeat 9 times until all debris is completely removed.

Brush manual lever

- a. As shown in Fig. 4-2, C, insert the short bristle brush under the manual lever.
- b. Slide left and right and rotate the brush once.
- c. Withdraw the brush and clean the bristles with your fingertips in the cleaning solution.
- d. Repeat 9 times until all debris is completely removed.

Brush T-valve

- a. Thoroughly scrub the inside and opening of the T-shaped valve with a short bristled brush until all debris is removed.

4. Pump cleaning fluid

- a. Install the T-valve on the clamp port and ensure that the endoscope is completely immersed in the cleaning solution;
- b. Connect the suction hose to the clamp port and start the suction pump;
- c. Pump the cleaning solution for 30 s and turn off the suction pump;
- d. Remove the suction hose and soak it in the cleaning solution.

5. Inject cleaning fluid into clamp

- a. Connect an irrigation device to the clamp port of the endoscope and ensure that the endoscope is completely immersed in the cleaning solution;
- b. Inject cleaning fluid at least 15 times (750 mL) with a 50-mL syringe into the suction pipe and clamp pipe through the irrigation device;
- c. Remove the irrigation device from the endoscope and soak all accessories.

6. Cover the manual cleaning tank with a sealing cover to minimize the volatilization of cleaning solution.

7. Soak the endoscope, T-valve and all cleaning and disinfection instruments according to the time, temperature and concentration recommended by the detergent manufacturer.

Metrex EmPower cleaning agent at a concentration of 1:128 is recommended for use. The recommended cleaning temperature is 20°C-40°C, and soaking time is not less than 1 minute.

★ *Note: The cleaning solution should be changed after cleaning each piece of endoscope.*

4.2.4 Rinse

1. Place the endoscope, button, T-valve and all cleaning and disinfection instruments into a rinsing tank containing sterile water;
2. Install the T-valve at the clamp port and connect the suction hose to the T-valve.
3. Turn on the suction pump switch, start the suction function, and pump sterile water for 30 s;
4. Wash the external surface of endoscope and T-valve with flowing water, and put them into a large aseptic basin;
5. Start the suction function, suck air for 30 s, and turn off the suction pump;
6. Remove T-valve and suction hose from endoscope;
7. Dry the endoscope surface, button and T-valve with a lint free cloth.

★ *Note: The lint free cloth should be replaced after use.*

8. Check the endoscope and other cleaning and disinfection instruments for residual debris. If debris remains, wipe the surface again until no debris is found.

4.2.5 Disinfection

1. Place the endoscope, T-valve and all cleaning and disinfection instruments into a disinfection tank and immerse them in disinfectant solution;

2. Inject disinfectant at least 15 times (750mL) with a 50-mL syringe into the clamp tube through the T-valve and ensure that there is no bubble at the tip;

★ Note: Make sure that the endoscope is completely immersed in the disinfectant and that all the tubes of the endoscope are filled with disinfectant.

3. Remove the T-valve and immerse it in the disinfectant completely;

4. If there are bubbles attached to the endoscope surface or instrument, wipe them off with a clean, lint free cloth;

5. Cover the disinfection tank with a sealed cover to minimize the volatilization of the disinfectant;

6. Soak according to the time, temperature and concentration recommended by the disinfectant manufacturer.

HugeMed recommends the use of Metricide 28 Long-Life Activated Dialdehyde Solution with a concentration of 2.5% at 25°C soak for 90 minutes.

7. Replace the gloves and connect the T-valve to the clamp port of the endoscope.

8. Inject air into the clamp tube 15 times (750mL) with a 50-mL syringe through the T-valve to remove the disinfectant in the tube.

9. Remove the T-valve.

 **Warning**

- Do not use any strong alkaline / strong acid disinfectant to disinfect HU32.
 - Do not use medical alcohol or Iodophor to soak HU32.
 - Please do not place HU32 in a place with acetone, butanone and other organic solvents.
 - Do not disinfect HU32 products under high temperature and high pressure.
 - During disinfection, pay attention to the cleaning of lens glass at the tip of HU32 to avoid affecting the image effect.
 - Do not disinfect the endoscope with high pressure steam cleaner.
-
-

4.2.6 Final rinse

1. Place the endoscope, T-valve, all cleaning and disinfection instruments into the final rinsing tank containing sterile water, and thoroughly scrub all external surfaces with a lint free cloth.
2. Install the T-valve at the clamp port and connect the suction hose to the T-valve.
3. Turn on the suction pump switch, start the suction function, and suck sterile water for at least 2 min until there is no disinfectant residue;
4. Wash the external surface of endoscope and T-valve with sterile water and put them into a large aseptic basin;
5. Start the suction function, suck air for 60 s, and turn off the suction pump;
6. Remove the T-valve from the endoscope
7. Dry the external surface of endoscope, T-valve and all cleaning and disinfection instruments with a sterile lint free cloth.

★ *Note: The lint free cloth should be replaced after use.*

4.2.7 Dry

1. Put the endoscope, T-valve and all cleaning and disinfection instruments on a special drying table with sterile towel;

★ *Note: The sterile towel should be replaced every 4 hours;*

2. Inject 75% - 95% alcohol into the clamp tube at least 15 times (750 mL) with a 50-mL syringe;

★ *Attention: Alcohol is flammable, so please use with care.*

3. Inject air into the clamp tube at least 15 times (750 mL) with a 50-mL syringe through the clamp port;
4. Dry the external surface of the endoscope with a sterile *lint free cloth* .
5. Dry the inner wall of T-valve and clamp port with a sterile cotton swab;

4.2.8 Storage

1. Transportation and storage:

- 1) Ambient temperature range: 0 - 45 °C
- 2) Relative humidity range: 30-95%
- 3) Atmospheric pressure range: 700-1060 hpa

★ *The packaged Flexible Video Ureterorenoscope should be stored in a cool and dry room with relative humidity no more than 80%, no liquid contamination, no chemicals or explosive gas, no corrosive gas, and good ventilation.*

2. Before storage, the Flexible Video Ureterorenoscope must be completely dried and kept straight as far as possible. The insertion part should be kept in an environment without external force. The power switch should be turned off, and the power cord should be unplugged before storage of the image processor and cold light source.

3. The Ureterorenoscope case is not a safe place for storage. Please do not use the case to keep the Flexible Video Ureterorenoscope, to avoid infection.

4. If the Flexible Video Ureterorenoscope is found to be artificially damaged, such as teeth marks or signs of being bitten by patients on the surface of the insertion tube, as well as various faults caused by the operator or the buyer's self-disassembly, it is not within the scope of quality "Three Guarantees" repair.

4.2.9 Cleaning, Disinfection and Sterilization for Other Accessories

1. Accessories (such as brushes, etc.) should be carefully cleaned before disinfection according to the requirements of their respective instructions for use.

2. The best way is to use an ultrasonic cleaner for physical cleaning at particle level. If possible, these accessories should be sterilized with ethylene oxide and cleaned by flushing to eliminate toxic gases. When sterilization is not feasible, the accessories can be soaked and disinfected, then completely rinsed and dried.

4.3 Cleaning and disinfection of HUV-01

Before first use, the HUV-01 must be cleaned and disinfected according to corresponding cleaning instructions. Clean and disinfect HUV-01 immediately after each use.

 **Warning**

- Disconnect HUV-01 from any main power supply, remove all accessories, and make sure that HUV-01 is completely turned off before cleaning and disinfection.
 - When disconnecting HUV-01 from the power supply, pull the plug from the wall outlet.
-
-

4.3.1 Cleaning

Follow the procedures below to clean HUV-01 according to medical practice:

1. Prepare cleaning solutions using standard enzyme cleaners recommended by the manufacturer. Recommended detergents: mild enzyme, pH: 7-9, low foam (Enzol or equivalent).
2. Soak a piece of sterile gauze in the enzyme solution to ensure that the gauze is moist without dripping.
3. Thoroughly clean the buttons and housing of the host with the wet gauze, and avoid getting the device wet to prevent damage to the internal electronic components.
4. Use a sterile soft bristle brush that has been soaked in the enzyme solution to clean the button until debris are removed.
5. Wait for 10 minutes (or the time recommended by the detergent manufacturer) to activate the enzyme.
6. Wipe HUV-01 with a sterile gauze moistened with RO / DI water. Make sure to remove all residues of detergent.
7. Repeat steps 1 - 6.

4.3.2 Disinfection

1. Wipe the surface of HUV-01 with a sterile gauze moistened with the isopropyl alcohol or ethanol mixture listed below for approximately 15 minutes (about once every 2 minutes). Follow the safety procedures when handling isopropyl. Gauze should be wet but not dripping, as the liquid will affect the electronic components inside HUV-01. Pay close attention to the buttons, screen, housing, grooves and gaps on the HUV-01. Use sterile cotton swabs to clean these areas.

Liquid medicine	Concentration
Isopropyl alcohol	70-80%*

*Alternatively, use EPA registered hospital disinfectant wipes containing at least 70% isopropyl alcohol.

The manufacturer's safety precautions and operator's instructions must be followed.

After use, it must be stored as required in the guidelines until it is used again.

 **Warning**

- Only use the materials and methods listed in this section to clean or disinfect the H Vision.
 - The company does not assume any responsibility for damage or accidents caused by the
-
-

use of other materials or methods.

- Please ensure that the HUV-01 is in a dust-free environment. To prevent damage to the HUV-01, the following regulations must be observed:

Dilute the cleaning agent and disinfectant according to the manufacturer's requirements, or use the lowest possible concentration;

Do not use abrasive materials (such as steel wool or silver polish) and solvents like xylene and acetone to clean the HUV-01 so as to avoid damage to the HUV-01.

- Before cleaning, disconnect the HUV-01.
 - The cleaning and disinfection measures described in the instructions for use cannot replace the daily rules and regulations for the use of the equipment under any circumstances!
-
-

Cautions

- If you accidentally dump liquid on the HUV-01 and it does not work properly, please temporarily stop using it and immediately contact the dealer or manufacturer who sold this product to you as soon as possible.
 - Do not use high temperature and high pressure for disinfection.
 - Do not disinfect with high-concentration organic acids or non-organic acids, which is easy to corrode the equipment.
 - If a disinfectant containing acetaldehyde and amine is used on the same surface, the surface of the object may be discolored.
-

4.4 Transportation

1. Precautions for transportation and storage

This product is transported and stored after packaging. The packaged Ureterorenoscope should be stored in a well-ventilated room with a relative humidity of not more than 80%, and without corrosive gas. See Appendix A for specific storage and transportation conditions.

2. Maintenance of HU32

(1) If the HU32 needs to be repaired, please package with the original suitcase packaging and return it to Shenzhen HugeMed Technology Development Co., Ltd or its special maintenance station, together with the registration and description of the equipment fault, attached with customer information, such as the hospital address, postal code, contact person and phone number.

(2) HU32 non-fault problems can be solved by on-site operators. The repair of fault problems can only be carried out by Shenzhen HugeMed Medical Technology Development Co., Ltd. or its special maintenance station. Our company is not responsible for any injury or damage caused by repairs by personnel other than those mentioned above.

(3) In order to prevent infection and guarantee safety of all equipment maintenance personnel, the

equipment should be completely cleaned and disinfected before being returned for repair. If HU32 is used by HA positive patients or other infectious patients, please register and explain.

4.5 Product disposal and recycling

The service life of the Ureterorenoscope is about 3 years. Those that exceed the service life should be scrapped. Please contact the dealer or manufacturer who sold this product to you as soon as possible for more relevant information.

You can make the following disposal:

1. The scrapped HU32 and HUV-01 can be sent back to the dealer or manufacturer who sold this product to you for proper recycling.
2. HU30 can be disposed of in accordance with the local relevant regulations.

5. Technical Product Specification

5.1 HU Vision Specification

Table 5-1 Technical Parameters of HU Vision

Items	Specification (HU30)	Specification (HU32)
Optical system		
Angle of view	120°±15% in the air	120°±15% in the air
Viewing direction	0°-10°	0°-10°
Depth of field	3-100 mm	3-100 mm
Lighting	Optical fiber	Optical fiber
Insertion part		
Controllable bending part	≥270° up, ≥270° down	≥270° up, ≥270° down
Max. width of the insertion part	3.2 mm	3.2 mm
Working length	650 mm±3%	650 mm±3%
Instrument channel		
Mean inner diameter	1.2 mm	1.2 mm
Minimum width of channel	1.0 mm	1.0 mm
Use environment		
Temperature	10-35°C (50-90°F)	10-35°C (50-90°F)
Relative humidity	30-85%	30-85%
Atmospheric pressure	700-1060 hPa	700-1060 hPa
Altitude	≤3000 m	≤3000 m
Storage and transportation		
Temperature	0-45°C (32-113°F)	0-45°C (32-113°F)
Relative humidity	30-95%	30-95%
Sterilization method	EO (Ethylene Oxide Sterilization)	Immersion, cleaning and disinfection

Please note that if the insertion part is not kept straight, the bending angle of the controllable bending part will be affected.

There is no guarantee that instrument selected using this minimum width of channel will be compatible in combination.

5.2 H Vision Specification

5.3 HUV-01 technical parameters

Table 5-2 Technical parameters of HUV-01

Display default resolution	1,024*768
Default resolution	4: 3
Image output	500*500
Start time	≤10 s
Storage method	U disk / mobile hard disk
Power requirements	100-240V; 50/60HZ
Electric shock protection	Class II equipment, without internal power supply equipment
Operating environment	
Temperature	10-35°C (50-90°F)
Relative humidity	30-85%
Atmospheric pressure	700-1060 hPa
Altitude	≤2000 m
Storage and transportation environment	
Temperature	0-45°C (32-113°F)
Relative humidity	30-95%
Overall dimensions	
Width	240 mm
Length	300 mm
Height	60 mm
Weight	1 . 8 kg
Connection	
USB Connection	USB2.0
S-video Connection	Optional
HDMI Connection	Optional
DVI Connection	Optional
SDI Connection	Optional

Warning

- To avoid the risk of electric shock, the device can only be connected to a power supply with grounding protection.
- When disconnecting the device from the power supply, the plug must be pulled out of the wall socket.

6. Troubleshooting

If there any serious incidents occurred, contact with Hugemed, we will report to European Union as described in its own procedures which compliant with MDR. The hospital can report to the European Union followed its own procedures too.

If problems occur with the system, please use this troubleshooting guide to identify the cause and correct the error.

When troubles or failures other than those listed in the following table are observed, turn off the H Vision and turn it on again. If the problem still cannot be resolved, please contact HugeMed for repairing.

Table 6-1 Troubles shooting

The device does not turn on.	
Cause	Action
The power supply is not connected	Connect the device to the mains power.
The equipment is damaged.	Use a backup system and contact the manufacturer.
During startup, tooltip pops up and displays the failure configuration of FPGA	Turn off the H Vision by pressing and holding the ON/OFF button for at least 1 second. When the H Vision is off, restart it by pressing and holding the ON/OFF button again. If this does not solve the problem, please use a backup system and contact the manufacturer.
There is no live image on the left side of the screen but the user interface shows up on the display.	
Cause	Action
The HU Vision is not or poorly connected with the H Vision.	Turn off the device and insert the connector of the HU Vision into the corresponding socket on the H Vision.
There are communication problems between the H Vision and the HU Vision	Turn off the H Vision by pressing and holding the ON/OFF button for at least 1 second. When the H Vision is off, restart it by pressing and holding the ON/OFF button again.
The HU Vision is damaged.	Replace the HU Vision with a new one.
The image display is dark.	
Cause	Action
The optical path of the HU Vision and the H Vision is not connected.	Turn off the device and insert the connector of the HU Vision into the corresponding socket on the H Vision.
The H Vision light source is not turned on.	Turn on the light source of the H Vision and adjust the brightness as appropriate
The brightness level of the light source is too low.	Adjust the brightness of the light source as appropriate
The light source is damaged.	Use a backup system and contact the

	manufacturer.
The image shown on the left side is frozen.	
Cause	Action
A communication error has occurred between the HU Vision and the H Vision.	Turn off the H Vision by pressing and holding the ON/OFF button for at least 1 second. When the H Vision is off, restart it by pressing and holding the ON/OFF button again.
The current image has been frozen.	Unfreeze the image.
The HU Vision is damaged.	Replace the HU Vision with a new one.
Low picture quality	
Cause	Action
Light is reflecting on the H Vision screen.	Move the H Vision to a position where no direct light is shining on the screen.
Ambient light is too strong.	Decrease the brightness of the ambient light.
Dirty/damp screen.	Wipe the screen with a clean cloth.
Blood on the lens (distal tip).	Inject more lavage fluid. If the lens cannot be cleaned in this manner, withdraw the HU Vision and wipe the lens with a sterile gauze.
It is difficult to insert an endoscopic accessory through the channel.	
Cause	Action
Channel is blocked.	Flush the working channel with sterile saline using a syringe. If it is impossible to clear the working channel, prepare a new HU Vision.
Endoscopic accessory is too big.	Check that the accessory used is of the recommended size.

7. Appendix

7.1 List of accessories

If the following objects are found to be inconsistent with this information, please contact the manufacturer.

No.	Part name	Quantity	Remarks
1	HUV-01 host	1	
2	HU32 handle	1	
3	HU30 handle	1	
4	Power cord	1	European standard
5	Power cord	1	China standard
6	Power cord	1	U.S. Standard
7	Signal connection line	1	HDMI, S-Video, DVI, SDI optional
8	USB data cable	1	
9	Certificate of conformity	1	
10	Instructions for use	1	

The way to access the electronic Instructions for use:

The url of HU30:

<http://www.hugemed.net/Product/Single-use-Endoscope/Flexible-Video-Ureterorenoscope-HU30>

The url of HU32:

<http://www.hugemed.net/Product/Reusable-Endoscope/Flexible-Video-Ureterorenoscope-HU32>

The url of HUV-01:

<http://www.hugemed.net/Product/Reusable-Endoscope/Flexible-Video-Ureterorenoscope-HUV-01>

Then click the green menu “Manuel download” the eIFU will show on the website.

7.2 EMC

HUV-01 conforms to IEC60601-1-2 Medical electrical equipment-Part 1-2: General requirements for Safety-Collateral Standard: Electromagnetic Compatibility Requirements and Tests.

Note

- The use of accessories, sensors and cables outside the specified range may increase the electromagnetic emission of HUV-01 and / or reduce the electromagnetic immunity of HUV-01.
 - Do not use HUV-01 close to or stacked with other equipment. When necessary, HUV-01 should be closely observed to ensure that it operates properly in the configuration used.
 - The HUV-01 needs to be specially protected with regard to EMC, and installed and maintained in an environment that meets the following EMC requirements.
 - Avoid using HUV-01 and MRI (Nuclear Magnetic Resonance Imaging) or similar equipment at the same time; otherwise it may cause equipment failure or equipment breakdown due to electromagnetic interference.
 - Even if other equipment meets the CISPR emission requirements, it may cause interference to the HUV-01.
 - When the input signal amplitude is lower than the minimum value specified in the technical specifications, it may cause inaccurate measurement.
 - Portable and mobile RF communication equipment can affect the performance of the Ureterorenoscope.
-

Guidance and manufacturer's declaration-electromagnetic emissions		
HUV-01 is expected to be used in the electromagnetic environment specified below, and the purchaser or user should ensure that it is used in this electromagnetic environment:		
Emission test	Compliance	Electromagnetic environment-guidance
Radio frequency emission GB 4824	Group 1	HUV-01 uses radio frequency energy only for its internal functions. Therefore, its radio frequency emission is very low, and the possibility of causing interference to nearby electronic equipment is very small
Radio frequency emission GB 4824	Class A	HUV-01 is suitable for use in all non-domestic facilities and all facilities that are not directly connected to the residential public low-voltage power supply network for domestic use.
Radio frequency emission GB 17625.1	Not applicable	
Voltage fluctuation / flicker emission GB 17625.2	Not applicable	

Guidance and manufacturer's declaration–electromagnetic immunity

HUV-01 is expected to be used in the electromagnetic environment specified below, and the purchaser or user should ensure that it is used in this electromagnetic environment:

Immunity test	IEC 60601 test level	Comply with level	Electromagnetic environment – guidance
Electrostatic discharge GB/T 17626.2	±6 kV contact discharge ±8 kV air discharge	±6 kV contact discharge ±8 kV air discharge	The ground should be wood, concrete or ceramic tiles. If the ground is covered with synthetic materials, the relative humidity should be at least 30%.
Electrical fast transient burst immunity test GB/T 17626.4	±2 kV for power cord	±2 kV for power cord	The network power supply should have the quality used in a typical commercial or hospital environment.
Surge GB/T 17626.5	±1 kV line to ground ±2 kV line to ground	±1 kV line to ground ±2 kV line to ground	The network power supply should have the quality used in a typical commercial or hospital environment
Voltage dips , short interruptions and voltage variations on the power transmission line GB/T 17626.11	<5 % U_T , continue to 0.5 cycle (above U_T , temporary drip of >95%) 40% U_T , continue to 5 cycles (above U_T , temporary drip of 60%) 70% U_T , continue to 25 cycles (above U_T , temporary drip of 30%) <5 % U_T , continue to 5 s (above U_T , temporary drip of >95%)	<5% U_T , continue to 0.5 cycle (above U_T , temporary drip of >95%) 40% U_T , continue to 5 cycles (above U_T , temporary drip of 60%) 70% U_T , continue to 25 cycles (above U_T , temporary drip of 30%) <5% U_T , continue to 5s (above U_T , temporary drip of >95%)	The network power supply should have the quality used in a typical commercial or hospital environment. If the HUV-01 needs to run continuously during a power interruption, it is recommended that this Ureterorenoscope be powered by an uninterrupted power supply or battery
Power frequency magnetic field (50/60Hz) GB/T 17626.8	3A/m	3A/m, 50/60 Hz	Power frequency magnetic field should have the characteristics of power frequency magnetic field level in a typical place in a

			typical commercial or hospital environment
Note: U_T refers to the AC grid voltage before the test voltage is applied			

Guidance and manufacturer's declaration-electromagnetic immunity

HUV-01 is expected to be used in the electromagnetic environment specified below, and the purchaser or user should ensure its use in this electromagnetic environment:

Immunity test	IEC 60601/YY 0505 test level	Comply with level	Electromagnetic environment-guidance
Radio frequency conduction GB/T 17626.6	3 V (effective value) 150 kHz-80 MHz	3 V (effective value)	Portable and mobile RF communication equipment should not be closer to any part of this Ureterorenoscope than the recommended isolation distance, including cables. The distance should be calculated by the formula corresponding to the transmitter frequency. Recommended isolation distance $d = 1.2\sqrt{P}$ $d = 1.2\sqrt{P} \quad 80 \text{ MHz-}800 \text{ MHz}$ $d = 2.3\sqrt{P} \quad 800 \text{ MHz-}2.5 \text{ GHz}$ Wherein: P —According to the maximum rated output power of the transmitter provided by the transmitter manufacturer, in watts (W); d —Recommended isolation distance, in m ^b . The field strength of the fixed RF transmitter is determined by surveying the electromagnetic site ^s , and it should be lower than the compliance level in each frequency range ^d . Interference may occur in the vicinity of equipment marked with the following symbol. 
Radio frequency radiation GB/T 17626.3	3 V/m 80 MHz-2.5 GHz	3 V/m	

Note:

- For 80-800 MHz, use the formula corresponding to the higher frequency band .
- These guidelines may not be suitable for all situations. Electromagnetic propagation is affected by absorption and reflection from buildings, objects and people.

- a) For fixed transmitters, such as: base stations for wireless (cellular / cordless) telephones and terrestrial mobile radios, amateur radios, AM and FM radio broadcasts, and television broadcasts, the field strength cannot be accurately predicted theoretically. To assess the electromagnetic environment of fixed RF transmitters, surveys of electromagnetic sites should be considered. If the measured field strength of HUV-01 is higher than the above applicable RF compliance level, HUV-01 should be observed to verify its normal operation. If abnormal performance is observed, supplementary measures may be necessary, such as readjusting the direction or position of HUV-01.
- b) In the entire frequency range from 150KHz to 80MHz, the field strength should be less than 3 V/m.

Recommended isolation distance between portable and mobile RF communication equipment and HUV-01			
HUV-01 is expected to be used in an electromagnetic environment where radio frequency radiation disturbance is controlled. According to the maximum rated output power of the communication equipment, the purchaser or user can prevent electromagnetic interference by maintaining the minimum distance between the portable and mobile RF communication equipment (transmitter) and the VL3S as recommended below.			
Rated maximum output power of the transmitter	Corresponding isolation distance of transmitter at different frequencies / m		
	150 kHz - 80 MHz	80 MHz - 800 MHz	800 MHz - 2.5 GHz
W	$d = 1.2\sqrt{P}$	$d = 1.2\sqrt{P}$	$d = 2.3\sqrt{P}$
0.01	0.12	0.12	0.23
0.1	0.38	0.38	0.73
1	1.2	1.2	2.3
10	3.8	3.8	7.3
100	12	12	23
For the rated maximum output power of the transmitter not listed in the above table, the recommended isolation distance d in meter (m) can be determined by the formula in the corresponding transmitter frequency column, where P is the maximum output power of the transmitter provided by the manufacturer, in watts (W).			
Note:			
1. For 80 -800 MHz, use the formula corresponding to the higher frequency band.			
2. These guidelines may not be suitable for all situations. Electromagnetic propagation is affected by absorption and reflection from buildings, objects and people.			